

PowerMOS transistor

**BUK445-400A
BUK445-400B**

T-39-09

GENERAL DESCRIPTION

N-channel enhancement mode field-effect power transistor in a plastic full-pack envelope. The device is intended for use in Switched Mode Power Supplies (SMPS), motor control, welding, DC/DC and AC/DC converters, and in general purpose switching applications.

QUICK REFERENCE DATA

SYMBOL	PARAMETER	MAX.	MAX.	UNIT
	BUK445	-400A	-400B	
V_{DS}	Drain-source voltage	400	400	V
I_D	Drain current (DC)	4.0	3.8	A
P_{tot}	Total power dissipation	30	30	W
$R_{DS(ON)}$	Drain-source on-state resistance	0.8	1.0	Ω

MECHANICAL DATA

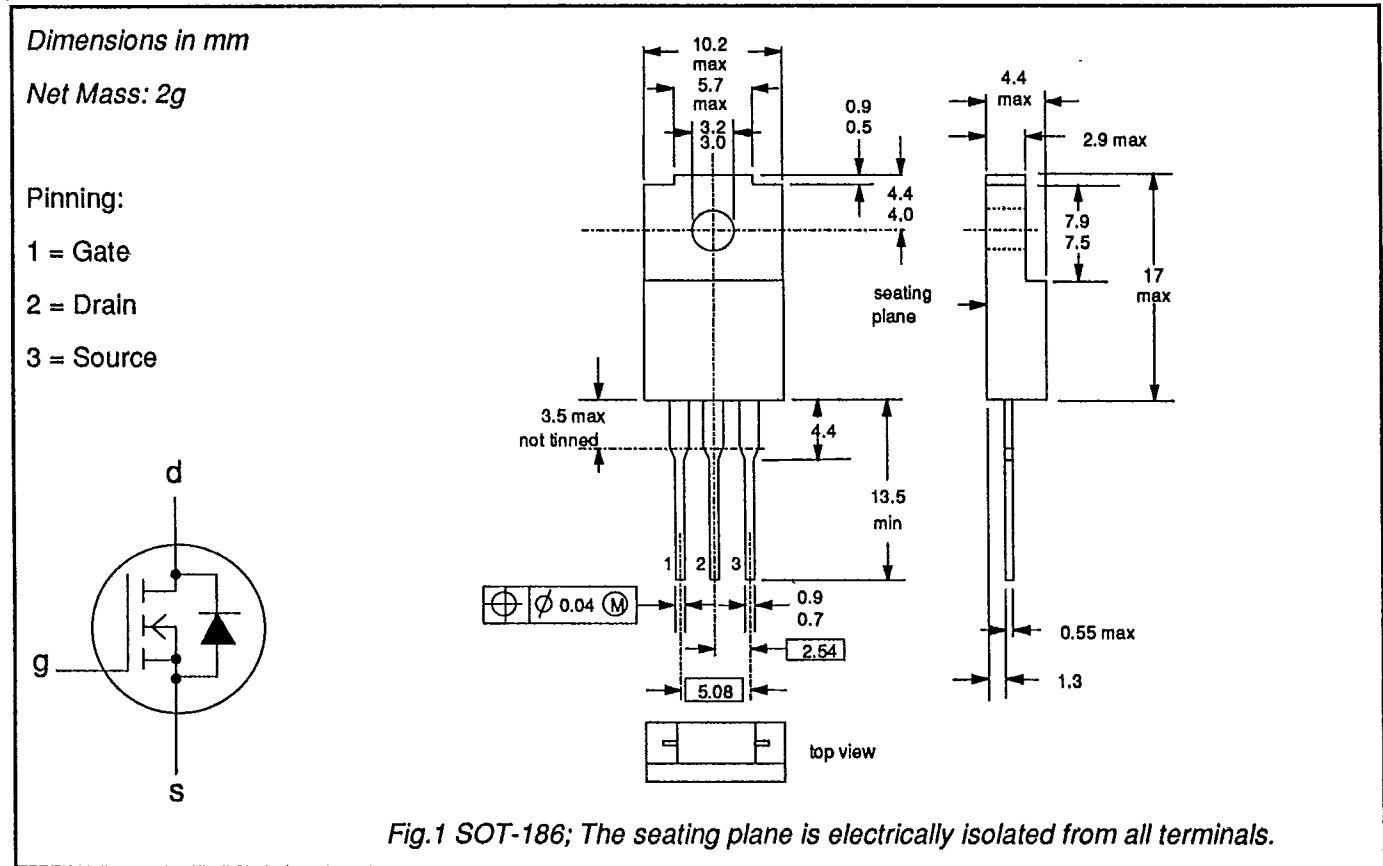

Notes

1. Observe the general handling precautions for electrostatic-discharge sensitive devices (ESDs) to prevent damage to MOS gate oxide.
2. Accessories supplied on request: refer to Mounting instructions for F-pack envelopes.

PowerMOS transistor

BUK445-400A
BUK445-400B

T-39-09

RATINGS

Limiting values in accordance with the Absolute Maximum System (IEC 134)

SYMBOL	PARAMETER	CONDITIONS	MIN.	MAX.		UNIT
				-400A	-400B	
V_{DS}	Drain-source voltage	-	-	400		V
V_{DGR}	Drain-gate voltage	$R_{GS} = 20 \text{ k}\Omega$	-	400		V
$\pm V_{GS}$	Gate-source voltage	-	-	30		V
I_D	Drain current (DC)	$T_{hs} = 25 \text{ }^\circ\text{C}$	-	4.0	3.6	A
I_D	Drain current (DC)	$T_{hs} = 100 \text{ }^\circ\text{C}$	-	2.5	2.3	A
I_{DM}	Drain current (pulse peak value)	$T_{hs} = 25 \text{ }^\circ\text{C}$	-	16	14	A
P_{tot}	Total power dissipation	$T_{hs} = 25 \text{ }^\circ\text{C}$	-	30		W
T_{stg}	Storage temperature	-	-55	150		$^\circ\text{C}$
T_j	Junction Temperature	-	-	150		$^\circ\text{C}$

THERMAL RESISTANCES

From junction to heatsink	with heatsink compound	$R_{th-j-hs} = 4.1 \text{ K/W}$
From junction to ambient		$R_{th-j-a} = 55 \text{ K/W}$

STATIC CHARACTERISTICS

 $T_{hs} = 25 \text{ }^\circ\text{C}$ unless otherwise specified

SYMBOL	PARAMETER	CONDITIONS	MIN.	TYP.	MAX.	UNIT
$V_{(BR)DSS}$	Drain-source breakdown voltage	$V_{GS} = 0 \text{ V}; I_D = 0.25 \text{ mA}$	400	-	-	V
$V_{GS(TH)}$	Gate threshold voltage	$V_{DS} = V_{GS}; I_D = 1 \text{ mA}$	2.1	3.0	4.0	V
I_{DSS}	Zero gate voltage drain current	$V_{DS} = 400 \text{ V}; V_{GS} = 0 \text{ V}; T_j = 25 \text{ }^\circ\text{C}$	-	2	20	μA
I_{DSS}	Zero gate voltage drain current	$V_{DS} = 400 \text{ V}; V_{GS} = 0 \text{ V}; T_j = 125 \text{ }^\circ\text{C}$	-	0.1	1.0	mA
I_{GSS}	Gate source leakage current	$V_{GS} = \pm 30 \text{ V}; V_{DS} = 0 \text{ V}$	-	10	100	nA
$R_{DS(ON)}$	Drain-source on-state resistance	$V_{GS} = 10 \text{ V}; I_D = 2.5 \text{ A}$	-	0.7	0.8	Ω
		BUK445-400A	-	0.9	1.0	Ω
		BUK445-400B	-	0.9	1.0	Ω

DYNAMIC CHARACTERISTICS

 $T_{hs} = 25 \text{ }^\circ\text{C}$ unless otherwise specified

SYMBOL	PARAMETER	CONDITIONS	MIN.	TYP.	MAX.	UNIT
g_{fs}	Forward transconductance	$V_{DS} = 25 \text{ V}; I_D = 2.5 \text{ A}$	3.5	4.5	-	S
C_{iss}	Input capacitance	$V_{GS} = 0 \text{ V}; V_{DS} = 25 \text{ V}; f = 1 \text{ MHz}$	-	750	1000	pF
C_{oss}	Output capacitance		-	120	180	pF
C_{rss}	Feedback capacitance		-	50	70	pF
t_{don}	Turn-on delay time	$V_{DD} = 30 \text{ V}; I_D = 2.7 \text{ A}; V_{GS} = 10 \text{ V}; R_{GS} = 50 \text{ }\Omega;$	-	10	25	ns
t_r	Turn-on rise time	$R_{gen} = 50 \text{ }\Omega$	-	25	40	ns
t_{doff}	Turn-off delay time		-	120	140	ns
t_f	Turn-off fall time		-	40	65	ns
L_d	Internal drain inductance	Measured from drain lead 6 mm from package to centre of die	-	4.5	-	nH
L_s	Internal source inductance	Measured from source lead 6 mm from package to source bond pad	-	7.5	-	nH

ISOLATION

 $T_{hs} = 25 \text{ }^\circ\text{C}$ unless otherwise specified

SYMBOL	PARAMETER	CONDITIONS	MIN.	TYP.	MAX.	UNIT
V_{isol}	Repetitive peak voltage from all three terminals to external heatsink	R.H. $\leq 65\%$; clean and dustfree	-	-	1500	V
C_{isol}	Capacitance from T2 to external heatsink	$f = 1 \text{ MHz}$	-	12	-	pF

PowerMOS transistor

BUK445-400A
BUK445-400B

T-39-09

REVERSE DIODE RATINGS AND CHARACTERISTICS

$T_{hs} = 25\text{ }^{\circ}\text{C}$ unless otherwise specified

SYMBOL	PARAMETER	CONDITIONS	MIN.	TYP.	MAX.	UNIT
I_{DR}	Continuous reverse drain current	-	-	-	4.0	A
I_{DRM}	Pulsed reverse drain current	-	-	-	16	A
V_{SD}	Diode forward voltage	$I_F = 4\text{ A}; V_{GS} = 0\text{ V}$	-	1.1	1.4	V
t_{rr}	Reverse recovery time	$I_F = 4\text{ A}; -di_F/dt = 100\text{ A}/\mu\text{s}; V_{GS} = 0\text{ V}; V_R = 100\text{ V}$	-	1000	-	ns
Q_{rr}	Reverse recovery charge	$I_F = 4\text{ A}; -di_F/dt = 100\text{ A}/\mu\text{s}; V_{GS} = 0\text{ V}; V_R = 100\text{ V}$	-	5.0	-	μC

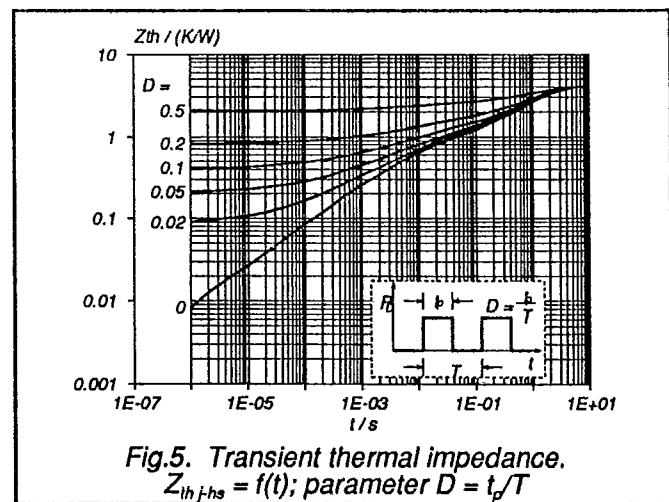
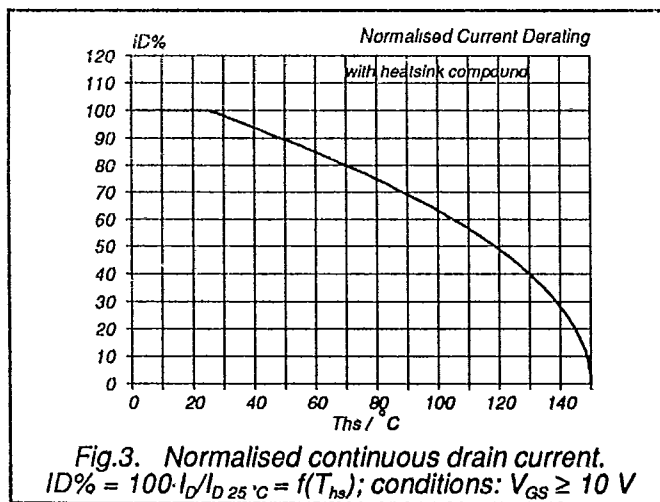
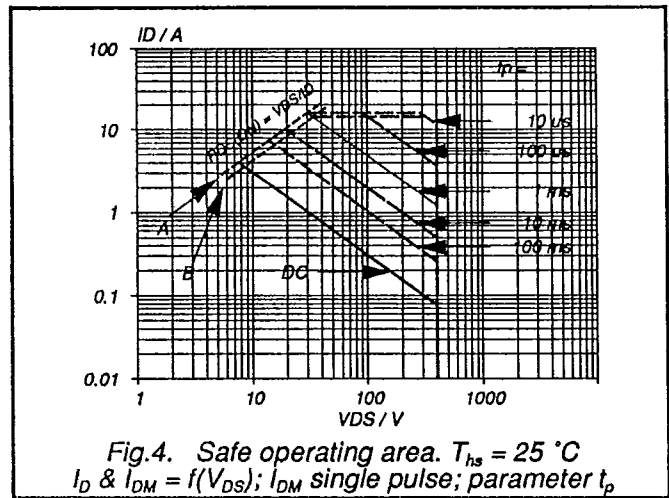
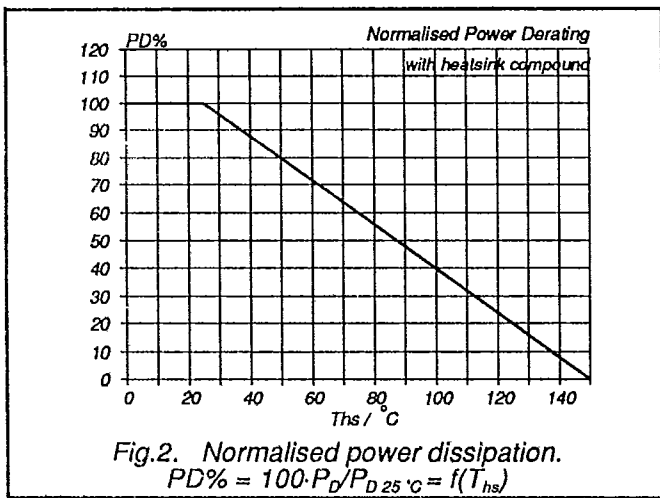

PowerMOS transistor

BUK445-400A
BUK445-400B

T-39-09

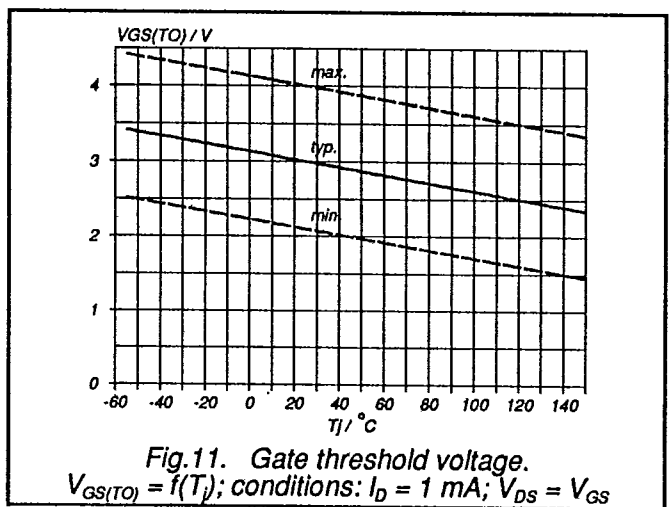
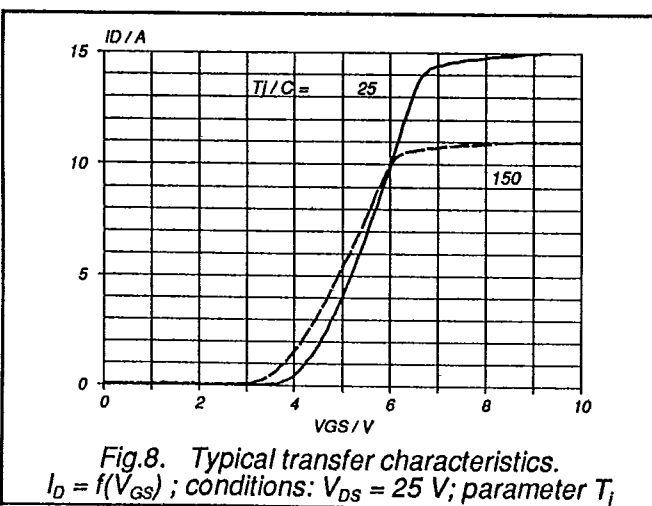
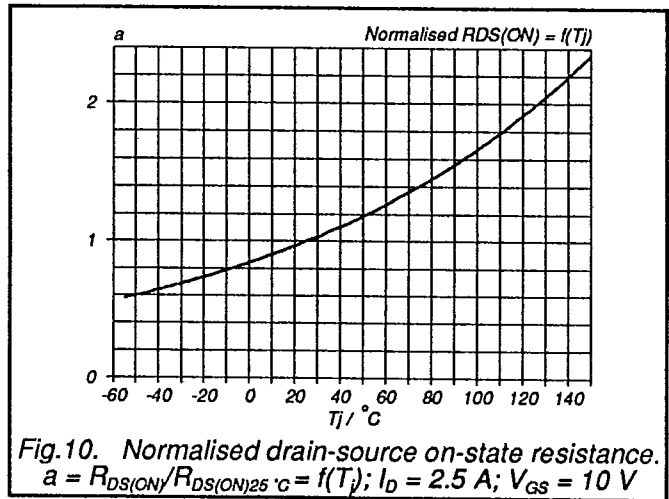
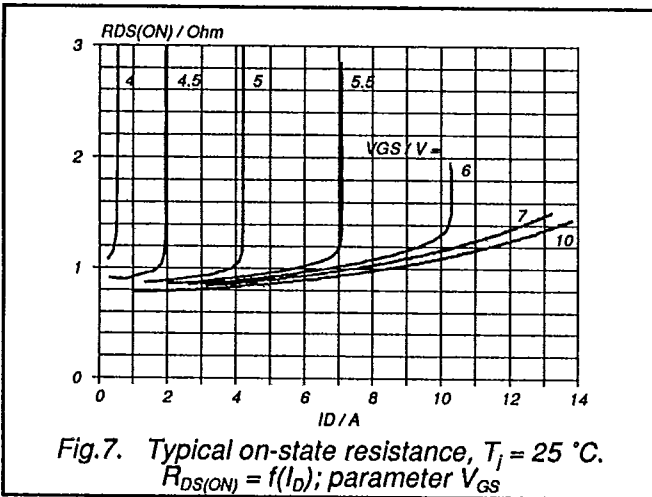
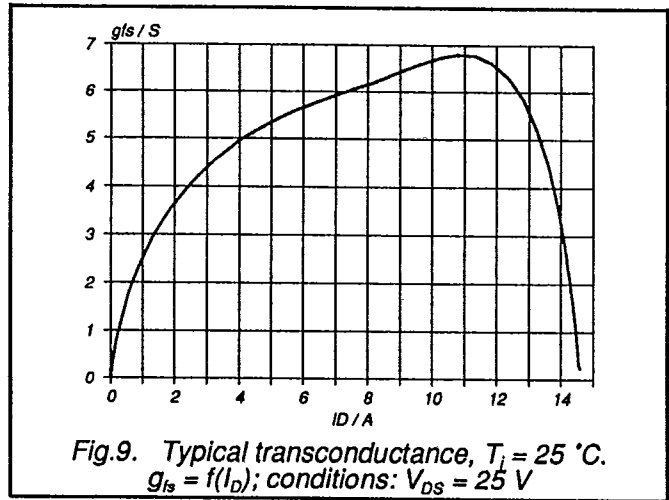
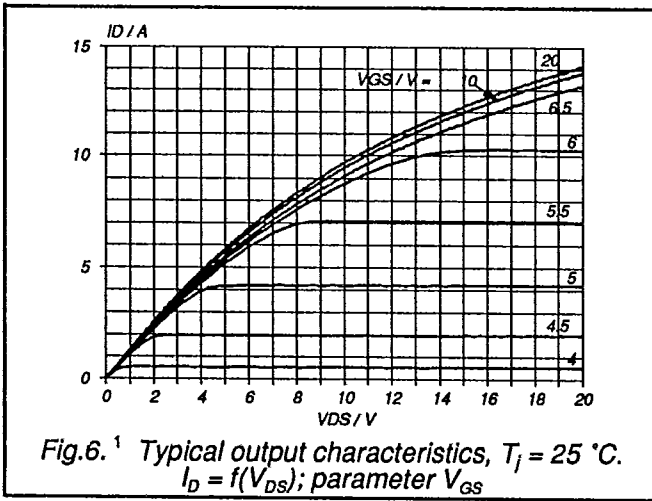

PowerMOS transistor

BUK445-400A
 BUK445-400B

T-39-09

